

LED RECESSED PANEL LIGHT

24W 165mm cut-out (6.5")



KEY DATA

Power	24W
IP Rating	IP20
Dimensions	φ178×27mm
Cut-out size	φ165mm
Luminous Flux	2300Lm
Colour Temperature	4000K/6500K
Warranty	One year

Model Number

PL RD 24w

TECHNICAL SPECIFICATIONS

Input Voltage	100-240V AC
Power Factor	0.96
LED Type	SMD 2835
LED Luminous Flux	3456Lm
Luminous Efficacy	96Lm/W
LED Manufacturer	RUNLITE
LED Circuit Mode	(24)S*(6)P=(144)PCS
LED Board Base Type	1060
Driver Output	72VDC 300mA
Driver Specifications	Non-Isolated
Total Circuit Power (W)	24±2
Electrical Class	1
Colour Rendering	>80 CRI
Lamp Viewing Angle	120°
Supply Current	104mA
Operating Temp.	-15 to +50°C
Lifespan	30,000 hours
Fire Rating	V-0
Energy Efficiency Index (EEI)	0.14 (A+)
Diffuser Material	Polystyrene
Housing Material/Colour	Aluminium/White
Weight	960g

DIMENSIONS

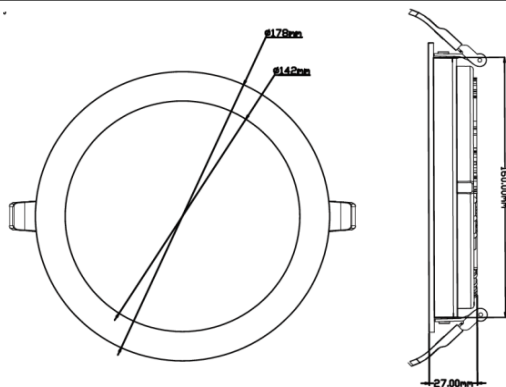

LIGHT & LUX DISTRIBUTION CURVE

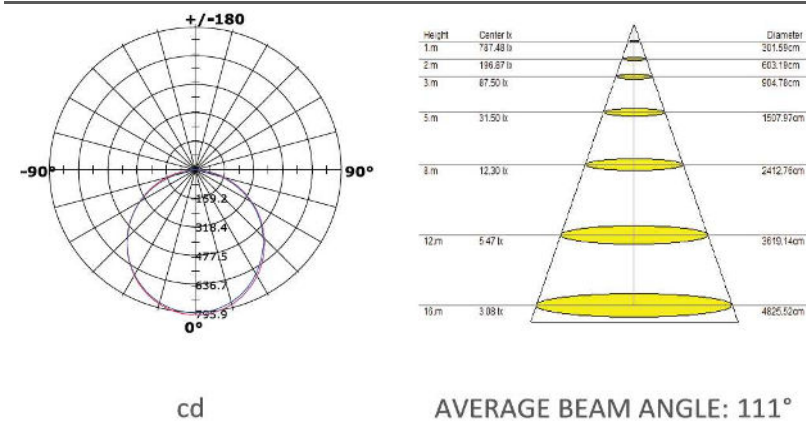

PRODUCT FEATURES:

1. Using high lumen SMD light source
2. Using good reflectivity light, it is thinner and brighter, the light is more equally.
3. Low voltage & constant current driver, no glare, the light is soft.
4. Launch in 0.01sec, no flashing, no noise, no radiation and energy saving.
5. This product can show high brightness, without seeing the lamp itself.